

The FL6RBND/S is a fullrange driver offering an extraordinary performance and sound clarity.

An aluminium cone with excellent internal damping together with a perfectly matching surround gives a smooth and extended frequency response.

The fabric spider reflects very little acoustic energy to the cone and offers outstanding stiffness linearity. The stiff and stable SPCC steel chassis keeps the critical components in perfect alignment.

The pole piece features a copper cap to ensure exceptional linearity in the force factor and coil inductance.

Small size combined with an excellent performance makes this driver the perfect choice for any application where limited space is a critical parameter.

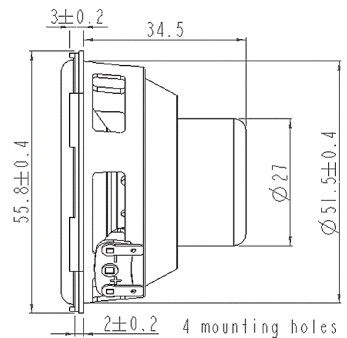
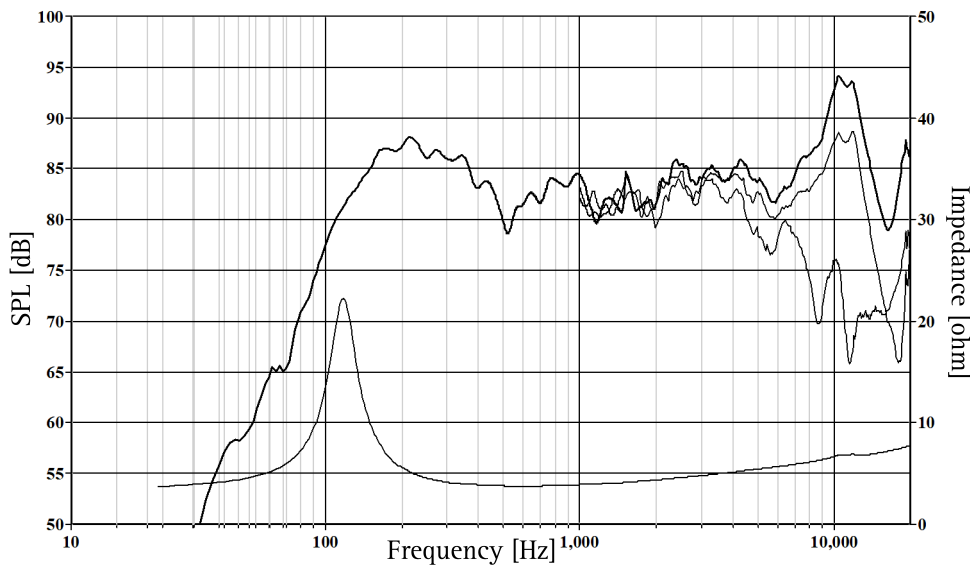

The frequency responses above show measured free field sound pressure in 0, 30, and 60 degrees angle using a IEC baffle. Input 2.83 VRMS, microphone distance 1m. The impedance is measured in free air without baffle using a 2V sine signal.

Nominal Impedance	4 Ohms	Voice Coil Resistance	3.88 Ohms
Recommended Frequency Range	200 - 20000 Hz	Voice Coil Inductance	0.13 mH
Short Term Power Handling *	12 W	Force Factor	3.2 N/A
Long Term Power Handling *	10 W	Free Air Resonance	117 Hz
Characteristic Sensitivity (2,83V, 1m)	84.54 dB	Moving Mass	2.39 g
Voice Coil Diameter	19.6 mm	Suspension Compliance	0.78 mm/N
Voice Coil Height	9 mm	Suspension Mechanical Resistance	0.55 Ns/m
Air Gap Height	3 mm	Effective Piston Area	17.35 cm ²
Linear Coil Travel (p-p)	8.7 mm	VAS	0.33 Litres
Maximum Coil Travel (p-p)	9.4 mm	QMS	3.2
Magnetic Gap Flux Density	0.691 T	QES	0.66
Magnet Weight	0.023 kg	QTS	0.55
Total Weight	0.087 kg		