

L19RNX1 is a high-fidelity woofer with a very stiff and optimally shaped aluminium cone. This pushes the cone break-up high up in frequency and avoid any resonances in the working range for a very natural and clean sound.

A titanium voice coil former with a long copper winding for excellent force transfer, transient sound reproduction and large linear excursion. A unique radial reinforced rubber surround reduces radial resonances and prevents surround break up at large excursions. This combination results in very low mechanical damping for better clarity and brings out the micro details in the music.

An FEA optimised magnet system with precisely fitted copper parts for excellent linearity, high power handling and low distortion.

The extremely stiff and stable injection moulded metal basket keeps the critical components in perfect alignment. Large windows in the basket both above and below the spider reduce sound reflection, air flow noise and cavity resonance to a minimum.

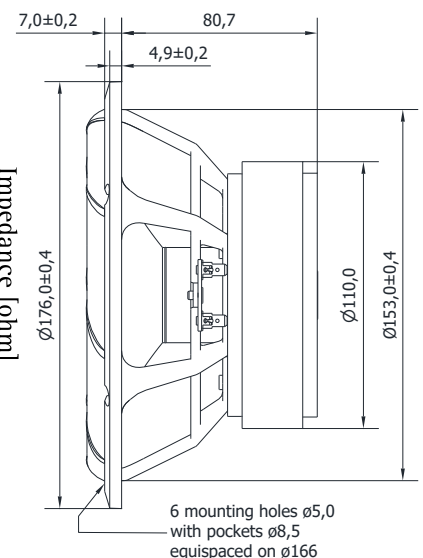
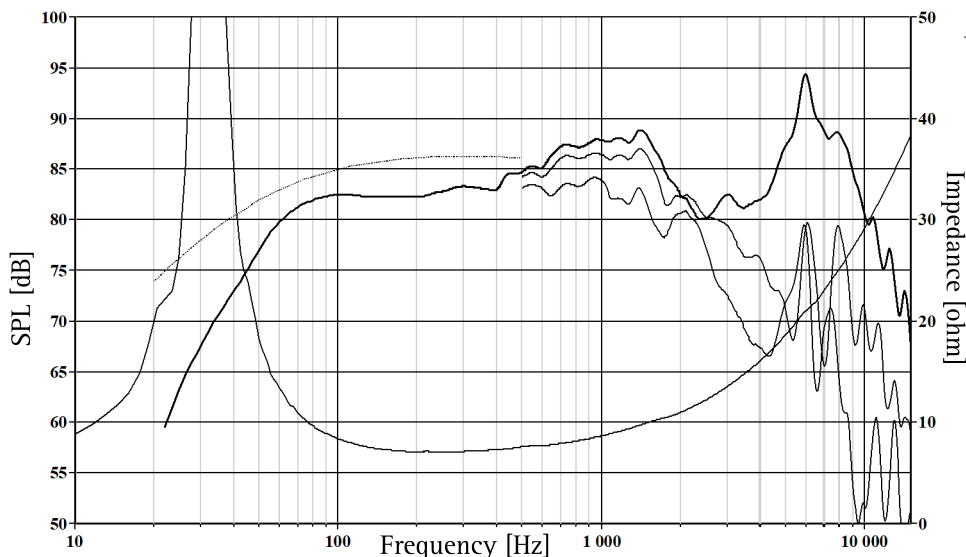

The frequency responses above show measured free field sound pressure in 0, 30, and 60 degrees angle using a 12L closed box. Input 2.83 VRMS, microphone distance 0.5m, normalized to SPL 1m. The dotted line is a calculated response in infinite baffle based on the parameters given for this specific driver. The impedance is measured in free air without baffle using a 2V sine signal.

Nominal Impedance	8 Ohm	Voice Coil Resistance	6.2 Ohm
Recommended Frequency Range	20 - 3000 Hz	Voice Coil Inductance	0.66 mH
Short Term Power Handling *	330 W	Force Factor	8.8 N/A
Long Term Power Handling *	200 W	Free Air Resonance	32 Hz
Characteristic Sensitivity (2,83V, 1m)	86 dB	Moving Mass	25.4 g
Voice Coil Diameter	39 mm	Suspension Compliance	0.96 mm/N
Voice Coil Height	20 mm	Suspension Mechanical Resistance	0.93 Ns/m
Air Gap Height	6 mm	Effective Piston Area	146 cm <sup>2</sup>
Linear Coil Travel (p-p)	14 mm	VAS	29 Litres
Maximum Coil Travel (p-p)	26 mm	QMS	5.50
Magnetic Gap Flux Density	1.3 T	QES	0.41
Magnet Weight	0.9 Kg	QTS	0.38
Total Weight	2.0 kg		